



NORBAR TORQUE TOOLS LTD
Wildmere Road, Banbury,
Oxfordshire, OX16 3JU
UNITED KINGDOM
Tel + 44 (0)1295 270333
Email enquiry@norbar.com



NORBAR TORQUE TOOLS PTE LTD
194 Pandan Loop
#07-20 Pantech Business Hub
SINGAPORE 128383
Tel + 65 6841 1371
Email enquires@norbar.sg



NORBAR TORQUE TOOLS
45-47 Raglan Avenue, Edwardstown,
SA 5039
AUSTRALIA
Tel + 61 (0)8 8292 9777
Email enquiry@norbar.com.au



NORBAR TORQUE TOOLS (SHANGHAI) LTD
91 Building-7F, No.1122 North Qinzhou Rd,
Xuhui District, Shanghai
CHINA 201103
Tel + 86 21 6145 0368
Email sales@norbar.com.cn



NORBAR TORQUE TOOLS INC
36400 Biltmore Place, Willoughby,
Ohio, 44094
USA
Tel + 1 866 667 2279
Email inquiry@norbar.us



NORBAR TORQUE TOOLS INDIA PVT. LTD
Plot No A-168, Khairne Industrial Area,
Thane Belapur Road, Mahape,
Navi Mumbai – 400 709
INDIA
Tel + 91 22 2778 8480
Email enquiry@norbar.in

www.norbar.com

PROFESSIONAL TORQUE TESTER PRO-TEST 60, 400 & 1500 SERIES 2 FOR USE WITH PRO-TEST'S FITTED WITH VERSION 37701.305 SOFTWARE



CONTENTS

Introduction	2
Part Numbers Covered by This Manual	2
Assembly Diagram	2
Parts Included	3
Accessories	3
Features and Functions	4
Operating Instructions	5
Mounting Positions	5
Locating Display Housing	6
Connecting Power Supply	6
Switching ON	6
Selecting Measurement Units	7
Selecting Measurement Mode	7
Fitting Hex Drive Adapter	7
Operating Tool to be Calibrated / Tested	7
Set Up	8
Language	8
Limits	8
Units	9
Serial Port	9
Thresholds	9
Modes	9
Limits	10
ISO 6789-1:2017	10
NON ISO 6789-1:2017	11
Operation	11
Status Indication	11
Serial Port	12
Parameters	12
Hyper Terminal®	12
Limit Output	13
Pin Connections	13
Data Output Example	13
Connector Type	13
Connecting Lead	13
Maintenance	14
Pro-Test Calibration	14
Cleaning	14
Disposal (Recycling considerations)	14
Specifications	15

INTRODUCTION

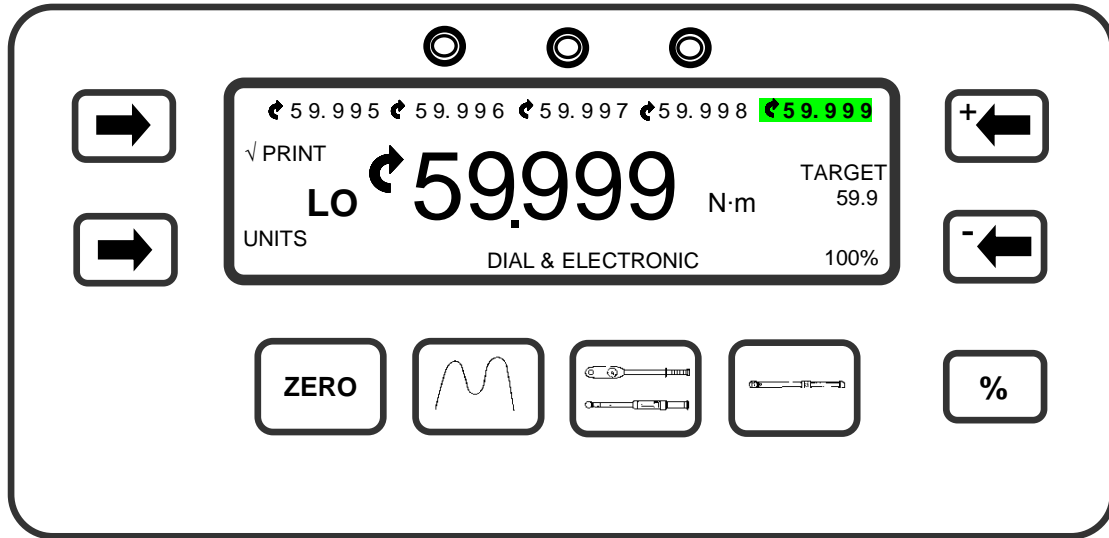

The Professional Torque Tester (Pro-Test) has been designed as an accurate, cost effective and easy to operate instrument for calibrating and testing all types of torque wrenches.

Part Numbers Covered By This Manual

- 43218 – PRO-TEST 60 series 2 TRANSDUCER & DISPLAY
- 43219 – PRO-TEST 400 series 2 TRANSDUCER & DISPLAY
- 43220 – PRO-TEST 1500 series 2 TRANSDUCER & DISPLAY

Assembly Diagram

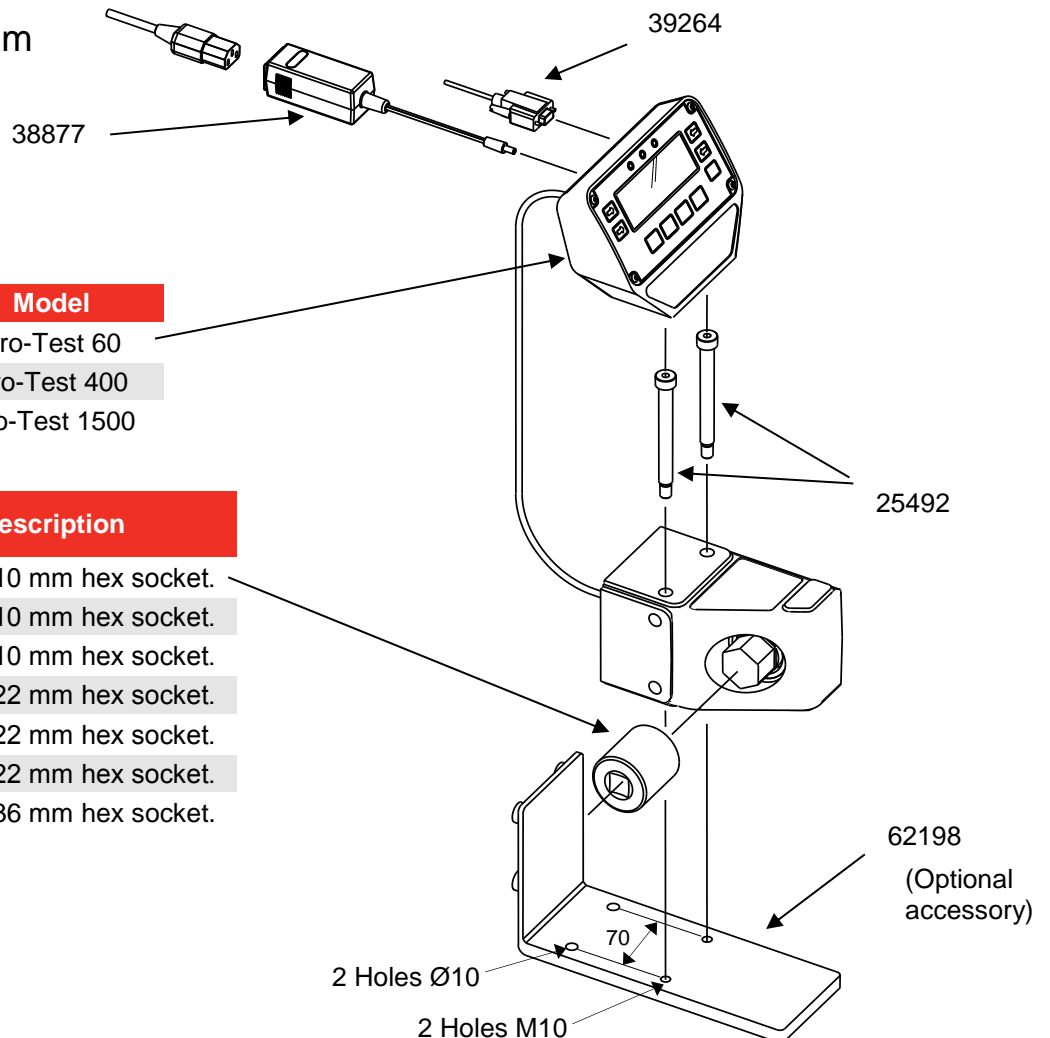

Part Number	Model
43218	Pro-Test 60
43219	Pro-Test 400
43220	Pro-Test 1500

Part Number	Description
29034	1/4" sq to 10 mm hex socket.
29067	3/8" sq to 10 mm hex socket.
29120	1/2" sq to 10 mm hex socket.
29079	3/8" sq to 22 mm hex socket.
29134	1/2" sq to 22 mm hex socket.
29189	3/4" sq to 22 mm hex socket.
29179	3/4" sq to 36 mm hex socket.

Parts Included

Pro-Test Instrument	Part Number	Pro-Test 60	Pro-Test 400	Pro-Test 1500
2 off M10 x 100mm long screw.	25492	✓	✓	✓
6 mm hex key.	24937	✓	✓	✓
¼" sq to 10 mm hex socket.	29034	✓	-	-
⅜" sq to 10 mm hex socket.	29067	✓	-	-
½" sq to 10 mm hex socket.	29120	✓	-	-
⅜" sq to 22 mm hex socket.	29079	-	✓	-
½" sq to 22 mm hex socket.	29134	-	✓	-
¾" sq to 22 mm hex socket.	29189	-	✓	-
¾" sq to 36 mm hex socket.	29179	-	-	✓
Operators Manual.	34299	✓	✓	✓
Calibration certificate.		✓	✓	✓
Quick reference card(s).	34302	✓	✓	✓
Serial data lead.	39264	✓	✓	✓
Power supply.	38877	✓	✓	✓
Power cable.		✓	✓	✓
Carry case.	60249	✓	✓	✓

Accessories

Part Number	Description
62198	Mounting bracket.
60253	12v DC power supply (in vehicle power adapter).
29190	1" to 36mm socket (for use with Pro-Test 1500).
60248	Serial Data Lead Kit.

FEATURES AND FUNCTIONS

- 3 sizes available covering the calibration ranges of:
1.2 to 60 N·m.
8 to 400 N·m.
30 to 1500 N·m.
- 5 digit resolution.
- ISO 6789-1:2017 limit mode with single press selection for 20%, 60% & 100% target values.
- NON ISO 6789-1:2017 limit mode with user defined tolerances.
- The pictorial keys allow direct access to measurement modes.

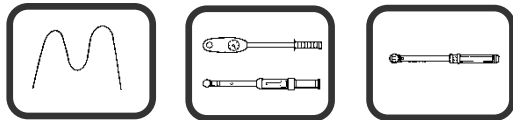

- Serial Port Connector for data output to PC's or printers.
- PRINT/NO PRINT ($\sqrt{\text{PRINT/X PRINT}}$) feature for control of serial port output.
- The last 5 readings taken are memorised on the display.
- SET UP menu's for:
 1. Language of operation,
 2. Limits mode required,
 3. Units of measurement enabled/disabled,
 4. Serial port communication parameters,
 5. Thresholds for 'CLICK & CAM' mode,
 6. Modes of measurement enabled/disabled.

OPERATING INSTRUCTIONS

NOTE: If the equipment is used in a manner not specified by the manufacturer, the protection provided by the equipment may be impaired.

1. Mounting Positions

Securely mount the Pro-Test transducer in the plane of operation required with the 2 fixing bolts supplied. This can be to a bench top, wall, or the mounting bracket part number 62198 (not included).

IMPORTANT: THE WHOLE OF THE TRANSDUCER MUST ALWAYS BE IN CONTACT WITH THE SUPPORTING SURFACE.

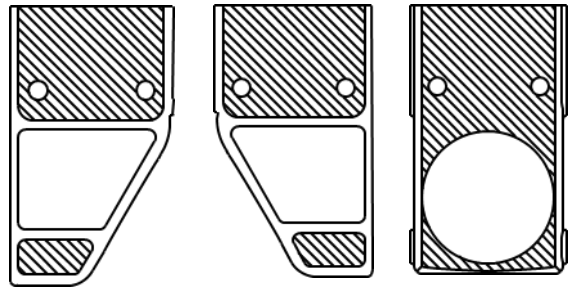

Clockwise **Only** Calibrating / Testing

Torque tighten to 20 N·m. (or hand tighten bolts with hex key provided)

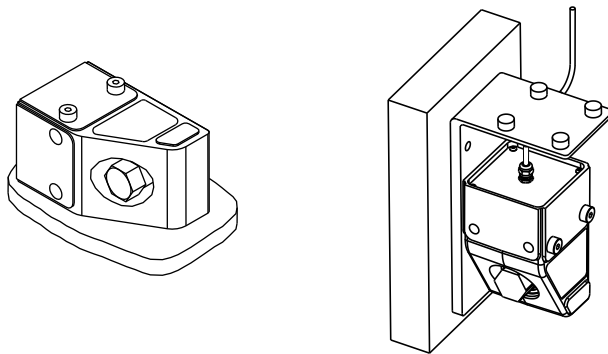

Anti-Clockwise **Only** Calibrating / Testing

Torque tighten to 20 N·m. (or hand tighten bolts with hex key provided)

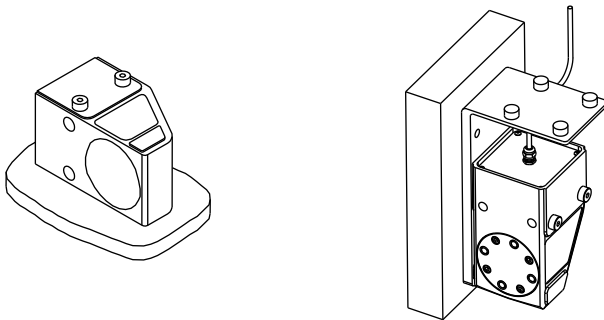

Clockwise and Anti-Clockwise Calibrating / Testing

IMPORTANT: BOLTS MUST BE TORQUE TIGHTENED TO 50 N·m. REPLACE BOLTS (PART NUMBER 25492) IF REMOVED.

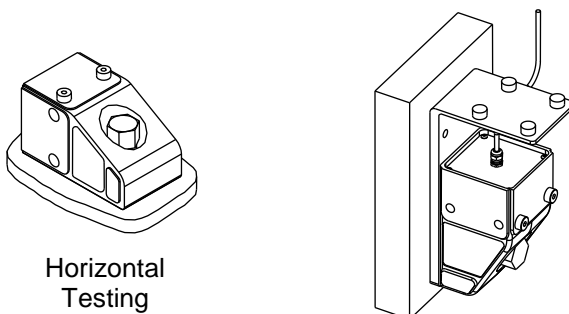

Horizontal Testing



2. Locating Display Housing

Locate Pro-Test Display housing on to the bolt heads securing the transducer housing. The display housing and transducer housing can also be secured on to a mounting bracket part number 62198 (not included).

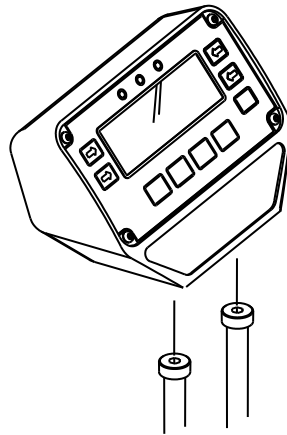

3. Connecting Power Supply

Plug Power Supply into back of display housing then plug power cable into Power Supply.

TIP: If the power cable has no plug fitted, wire as follows:

BROWN-LIVE BLUE-NEUTRAL GREEN / YELLOW-EARTH

If in doubt consult a qualified electrician.

4. Switching On

Switch ON Pro-Test ('I' in the down position).



WARNING: ALLOW PRO-TEST TO EQUALISE TO THE AMBIENT TEMPERATURE/ HUMIDITY BEFORE SWITCHING ON. WIPE OFF ANY MOISTURE BEFORE USE.

TIP: If there is no display when power is switched on:

- Check the Power Supply output connector is correctly plugged into the mating part on the back of the display housing.
- Check the fuse in the power cable plug.
- Check that the green LED is illuminated on the power supply.

Mode	Use	How it works.	Visual representation
 TRACK	Allow 5 minutes for the instrument to warm up and stabilise, then press 	Follows signal.	

TIP: For maximum accuracy exercise the transducer in the direction of use before pressing 'ZERO'.

5. Selecting Measurement Units





Select required units of measurement. Pressing and releasing the 'UNITS' button will step onto the next available unit of measurement.

TIP: Required units of measurement are not selectable.

- a) Conversion cannot be displayed within available digits on display, thus conversion is not allowed.
- b) Units required have been disabled. See SET UP.

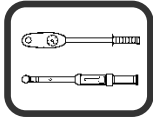
6. Selecting Measurement Mode

Press required button, see below:

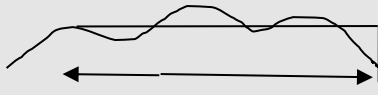
Button	Use	How it works	Visual representation
 DIAL & ELECTRONIC	Bending beam wrenches & Dial type wrenches.	Hold highest signal. Reset by pressing 	
 CLICK & CAM	Preset (click type) wrenches.	Captures the FIRST PEAK of torque and displays this for the selected AUTO RESET HOLD TIME before automatically resetting.	

TIP: Readings in CLICK & CAM mode are inconsistent.
Change FIRST PEAK SENSITIVITY to be less sensitive, see THRESHOLDS menu in SET UP.

7. Fitting Hex Drive Adapter

Fit adapter supplied to hex drive of transducer. Fit the tool to be calibrated / tested to the square drive of the adapter.

8. Operate Tool to Be Calibrated / Tested

Apply force to tool smoothly (do not snatch). Follow instructions for torque tool being tested.

SET UP

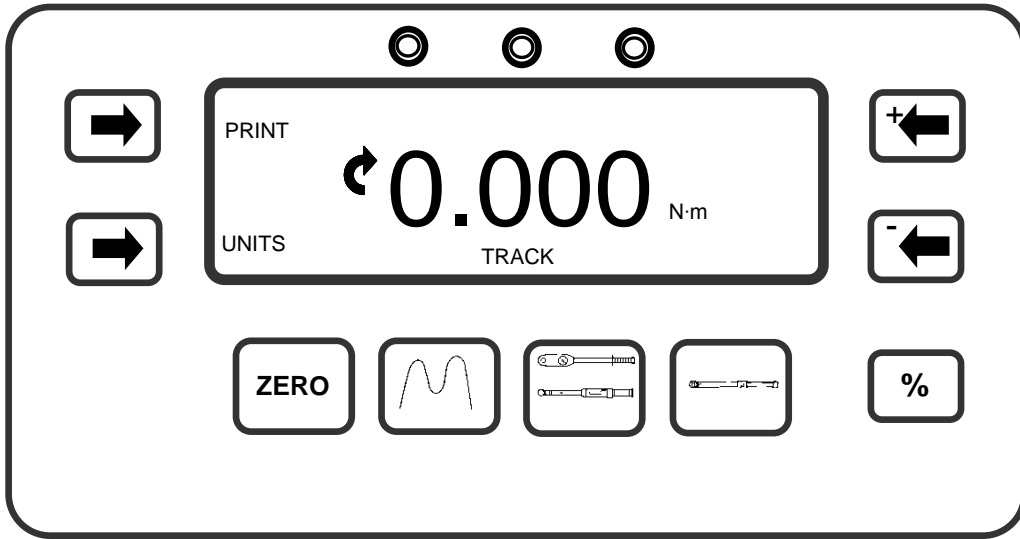

To enter SET UP, press 'UNITS' & 'PRINT' buttons simultaneously upon which the 'SOFTWARE VERSION NUMBER' will be displayed for 2 seconds.

1. Language



Press '↓' to select.
Press 'OK' for next menu.
Press 'EXIT' to end set up.

2. Limits



Press '↓' to select.
Press '√/X' to enable/disable.
Press 'OK' for next menu.
Press 'EXIT' to end set up.

TIP: If NON ISO 6789-1:2017 limit mode is enabled, 'OK' or 'EXIT' will go to the SET LIMITS menu (shown below).

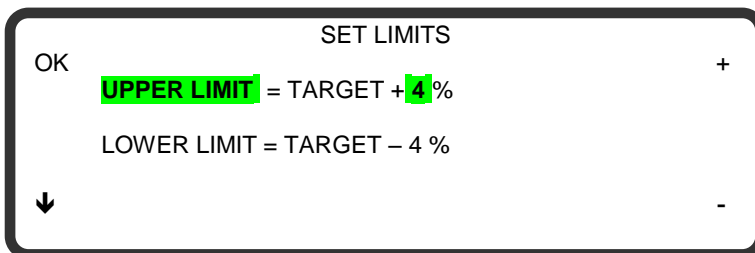

Press '↓' to select.
Press '+' or '-' to change the value displayed.
Press 'OK' for next menu.
Press 'EXIT' to end set up.

3. Units

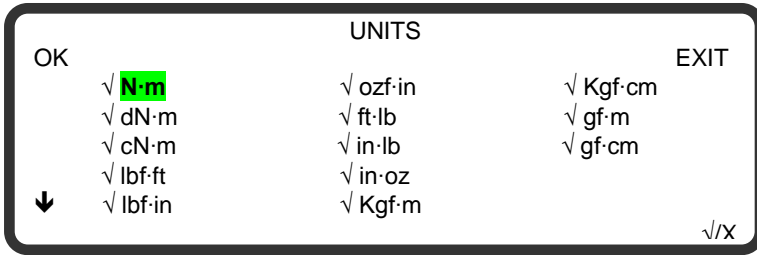

Press '↓' to select.
 Press '√/X' to enable/disable.
 Press 'OK' for next menu.
 Press 'EXIT' to end set up.

4. Serial Port

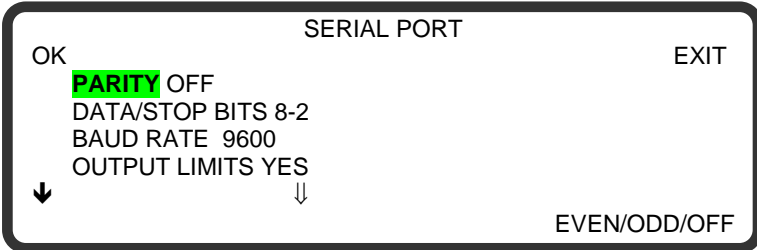

This menu consists of 2 screens: Press '↓' to select.

Press  to change setting.

Press 'OK' for next menu.
 Press 'EXIT' to end set up.

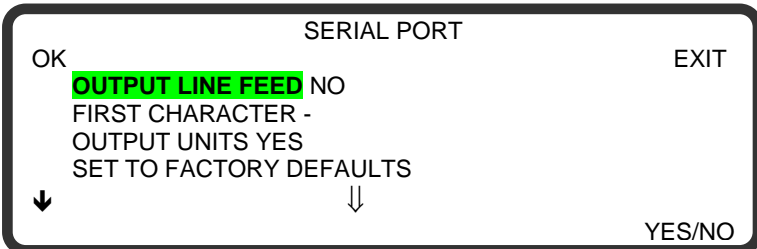

5. Thresholds

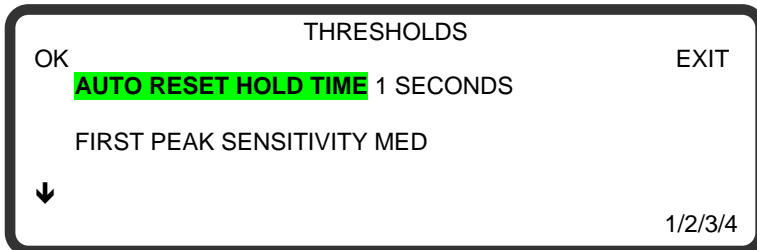

Press '↓' to select.
 Press  to change setting.
 Press 'OK' for next menu.
 Press 'EXIT' to end set up.

TIP: These settings only apply to 'CLICK & CAM' mode.

6. Modes

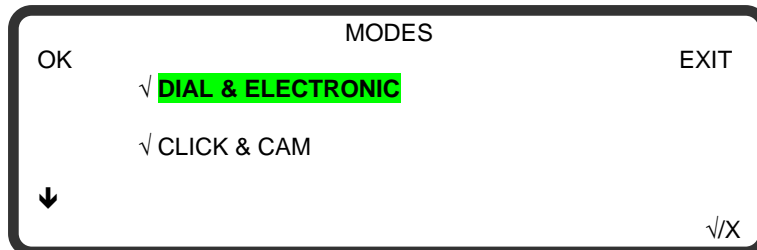





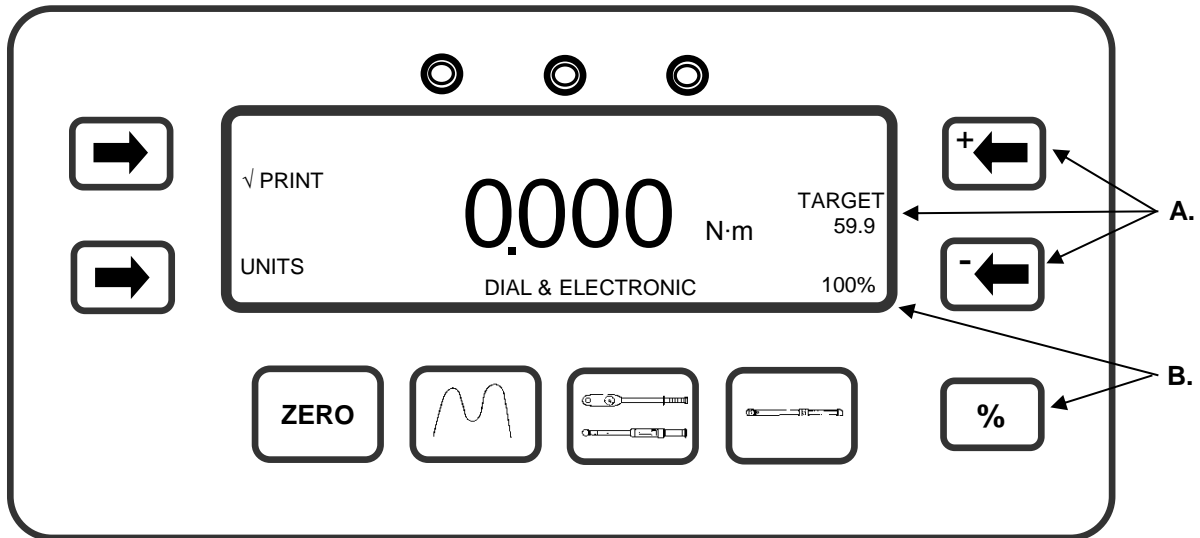

Press '↓' to select.
 Press '√/X' to enable/disable.
 Press 'OK' or 'EXIT' to end set up.

LIMITS

ISO 6789-1:2017



- A. To change the limit target value, use  or  in any measurement mode. The target value set is shown on the display. Keep either key depressed for fast target value change.
- B. The three calibration points (20%, 60% & 100%) are selected by pressing . The percentage value selected is shown on the display.

To adjust a calibration point percentage value (e.g. change the first calibration point from 20% to 10%) use  or  whilst holding down .

The Pro-Test automatically calculates the limits to ISO 6789-1:2017 by the following method:

$$\text{Deviation} = \frac{(\text{Displayed reading} - \text{Target value})}{\text{Target value}} \times 100$$

If the 100% target value is set above 10 N·m, the deviation must be within $\pm 4\%$. For a 100% target value of 10 N·m or below, the deviation must be within $\pm 6\%$.

Example: For a 100 N·m target value

Lower Limit = 96.0 N·m
Upper Limit = 104.0 N·m

TIP: For Indicating torque tools (Type I), the Pro-Test is designed for class B, C and E tools. Tools of class A and D should only be used with capacities of 10 N·m or below.

For Setting torque tools (Type II), the Pro-Test is programmed for Class A, B and C tools. Tools of class D, E, F and G should only be used with capacities of 10 N·m or below.

TIP: The maximum target value in lbf·ft (ft·lb) is 50 lbf·ft for the Pro-Test 60 and 300 lbf·ft for the Pro-Test 400.

NON ISO 6789-1:2017

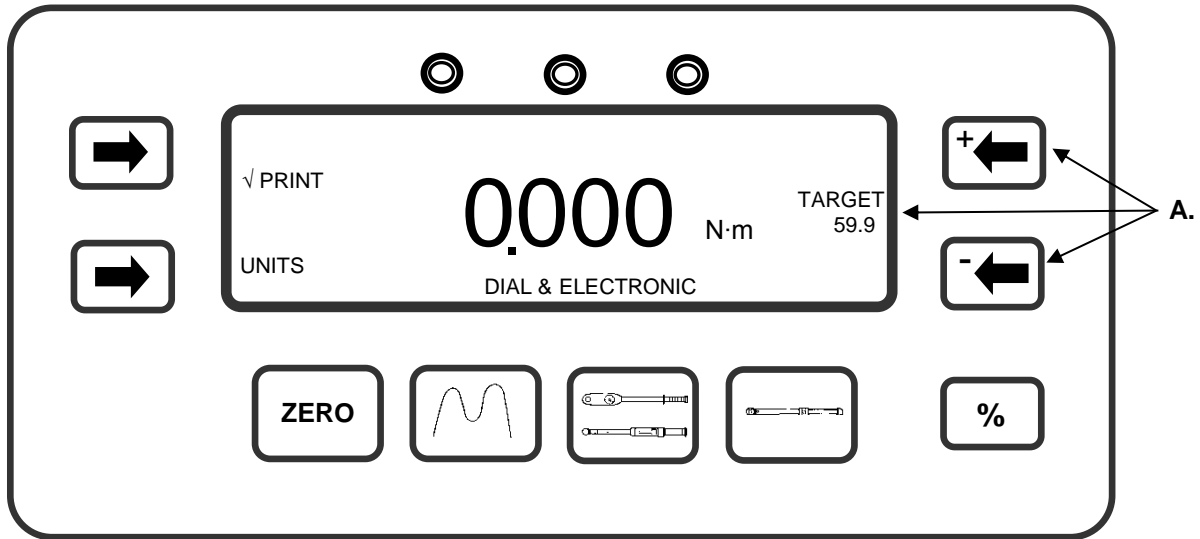

NON ISO 6789-1:2017 limit mode allows the user to set upper and lower limits from 0% to 99% of the target value.

- A. To change the limit target value, use  or  in any measurement mode. The target value set is shown on the display. Keep either key depressed for fast target value change.

UPPER LIMIT = TARGET + % OF TARGET

LOWER LIMIT = TARGET - % OF TARGET

The default % OF TARGET is set to 4%. See the SET UP section to change the default value.

Operation

Measurement Mode	Limit Operation
Track	Limits follow signal and are not held.
Dial & Electronic	Limits status is held until 'ZERO' is pressed.
Click & Cam	Limit status is held until after the auto reset timer has operated.

Limits are enabled to work in both the Clockwise and Counter clockwise directions.

Status Indication

Torque Signal	Display	LED's	Serial Port
Under lower limit	LO	Yellow	LO
Within limits	OK	Green	OK
Above upper limit	HI	Red	HI

SERIAL PORT

The serial port is for sending data to a PC or serial printer.

Measurement Mode	Data Output Operation
Track	When 'PRINT' is pressed.
Dial & Electronic	When 'ZERO' is pressed after a peak has been captured.
Click & Cam	Automatically after a first peak has been captured.

The data can include direction indication, limit status, measured value, units of measurement and line feed.

Parameters

Parameter	Options	Factory Defaults	Comments
Parity	ODD, EVEN or OFF.	'OFF'	The Parity Bit used for Parity Error.
Data-Stop bits	8-2, 8-1, 7-2, 7-1.	'8-2'	The format per character.
Baud rate	1200, 2400, 4800, 9600 or 19200.	'9600'	The speed of data output.
Output Limits	YES or NO.	'YES'	Limit status sent before data.
Output line feed	YES or NO.	'NO'	Line feed sent after data.
First character	- /+ & - /NONE.	'-'	Character sent before the data.
Output units	YES or NO.	'YES'	Torque units sent after data.
	SET TO FACTORY DEFAULTS.		Reset all settings.

Maximum number of characters per line = 24.

Transmitted data voltage levels are between +5 to +9 volts and -5 to -9 volts.

Configured as DTE (Data Terminal Equipment) and conforms to RS-232-C specifications.

TIP: If the serial port is not communicating with other equipment:

- a) Check that control word on the Pro-Test and the equipment receiving data match.
- b) Check that the baud rate is set to the same as the equipment receiving data.
- c) Check that the connecting lead is wired correctly at both ends if not using the lead supplied.
- d) Check if the equipment receiving data requires the units of measurement inhibited or a leading character.

TIP: If the serial output is being overwritten set 'OUTPUT LINE FEED' to YES.

Hyper Terminal®

The standard Hyper Terminal® program found in Microsoft® Windows allows the user to view and store serial port output data.

Limit Output

The serial port will output LO / OK / HI before the torque value when the limits are being used. Some software, including the Norbar 'Torque Wrench Calibration Software' (Part 37705.XXX), will not accept LO / OK / HI characters.

The following table gives all options for the FIRST CHARACTER setting and the OUTPUT LIMITS setting:

First Character	Direction	Limits Disabled Output Limits = NO	Limits Enabled Output Limits = YES
-	Clockwise	1.0335 N·m	LO 1.0335 N·m
	Anti Clockwise	-1.0335 N·m	LO -1.0335 N·m
+ & -	Clockwise	+1.0335 N·m	LO +1.0335 N·m
	Anti Clockwise	-1.0335 N·m	LO -1.0335 N·m
NONE	Clockwise	1.0335 N·m	LO 1.0335 N·m
	Anti Clockwise	1.0335 N·m	LO 1.0335 N·m

Pin Connections

Pin No	Function
1	Not Connected.
2	Received data (to Pro-Test).
3	Transmitted data (from Pro-Test).
4	Not Connected.
5	Signal ground 0V.
6	Not Connected.
7	Not Connected.
8	Not Connected.
9	Not Connected.

Data Output Example

Code : DP=Decimal Point. CR=Carriage Return. SP=Space.

Pro-Test with the serial port set to the factory defaults. Reading 1068.4 lbf·ft (clockwise):

1	0	6	8	DP	4	SP	l	b	f	DP	f	t	CR
---	---	---	---	----	---	----	---	---	---	----	---	---	----

Connector Type

9 way male 'D' type connector.

Connecting Lead

A 9 way female to 9 way female null modem connecting cable is included with the Pro-Test for connection to PC's with a 9 way male connector. Alternatively use the Serial Data Lead Kit (part number 60248).

MAINTENANCE

Pro-Test Calibration

Your Pro-Test has been supplied with a certificate of calibration. To maintain the specified accuracy it is recommended that the Pro-Test is recalibrated at least once per year. Re-calibration should be carried out at Norbar or by a Norbar approved agent, where all the facilities to ensure the instrument is functioning at maximum accuracy are available.

Cleaning

Do not use abrasives or solvent based cleaners.

Disposal (Recycling Considerations)

Component	Material
Back Panel	Stainless Steel
Transducer Shaft	Stainless Steel
Transducer Housing	Aluminium
Display Housing	Aluminium



This symbol on the product indicates that it must not be disposed of in the general waste.

Please dispose of according to your local recycling laws and regulations.

Contact your distributor or see the Norbar web site (www.norbar.com) for further recycling information.

SPECIFICATIONS

Calibration range: (2–100% of transducer capacity)	1.2 to 60 N·m (Pro-Test 60). 8 to 400 N·m (Pro-Test 400). 30 to 1500 N·m (Pro-Test 1500).
Resolution:	5 digits.
Torque conversions:	To 'BS 350:2004 Conversion factors for units'.
Display:	240 x 64 pixel dot matrix display. Update rate of three times per second (3Hz) in 'TRACK'.
Accuracy:	See calibration certificate.
Zero suppression:	± 1 LSD in 'TRACK' mode for Pro-Test 60. No suppression for Pro Test 400 & 1500. 'DIAL & ELECTRONIC' and 'CLICK & CAM' mode suppressed from 0 to approximately 0.5% of transducer capacity.
Units of measurement:	N·m, dN·m, cN·m, lbf·ft, lbf·in, ozf·in, ft·lb, in·lb, in·oz, kgf·m, kgf·cm & gf·m. PRO-TEST 60 also has gf·cm available.
First peak sensitivity:	2.5%(High), 5%(Med), or 10%(Low) of reading.
Auto reset hold time:	1, 2, 3 or 4 seconds.
Trigger from setting:	1.55% of transducer capacity.
Limit hysteresis:	0.5% of transducer capacity.
Operating temperature range:	+5°C to +40°C.
Storage temperature range:	-20°C to +70°C.
Maximum operating humidity:	85% Relative Humidity at 30°C.
Power supply:	90 to 264 Volts a.c. at 50-60 Hz input. 9V, 300 mA D.C. output (centre positive).
Power consumption:	2.25 W - maximum.
Power cable:	2 meters (6 ft 6 ins) long minimum.
Power cable plug fuse (if fitted):	1 Amp.
Case materials / finish:	Display and Transducer housings engineered in aluminium castings and finished in powder coated paint.
Environment:	IP 40. Indoor use within a light industrial environment.
Electromagnetic Compatibility: (EMC) Directive	In conformance with EN 61326 : 1997.
Low voltage directive:	In conformance with EN 61010-1 : 2001. To environmental conditions Pollution Degree 2 & Installation Category (Over voltage Category) II.
Mechanical overload:	150% of marked transducer capacity.
Dimensions:	Transducer 106 (H) x 106 (W) x 185 (D). Display 128 (H) x 185 (W) x 102 (D).
Weight: (Transducer with display)	Pro-Test 60 = 6.3 kg (13.9 lb). Pro-Test 400 = 6.4 kg (13.12 lb). Pro-Test 1500 = 7.3 kg (15.11 lb).

NOTE: Due to continuous improvement all specifications are subject to change without prior notice.

NOTES